

SHAD

ENGINEERED FOR RIDING



USER GUIDE TOP CASE

SH34

WWW.SHAD.ES

CARE AND MAINTENANCE



WARNING!

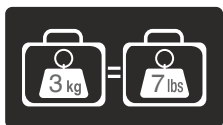

MAXIMUM WEIGHT

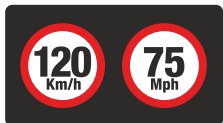

MAXIMUM SPEED, CHECK LOCAL LAWS.



ALWAYS SECURE AND LOCK PRODUCTS.



ONLY USE RECOMMENDED CLEANING PRODUCTS.



CASES ARE NOT DESIGNED TO PROTECT FRAGILE OBJECTS.

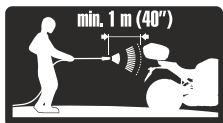

1 M. MINIMUM DISTANCE WITH POWER WASHER.

OPEN

1

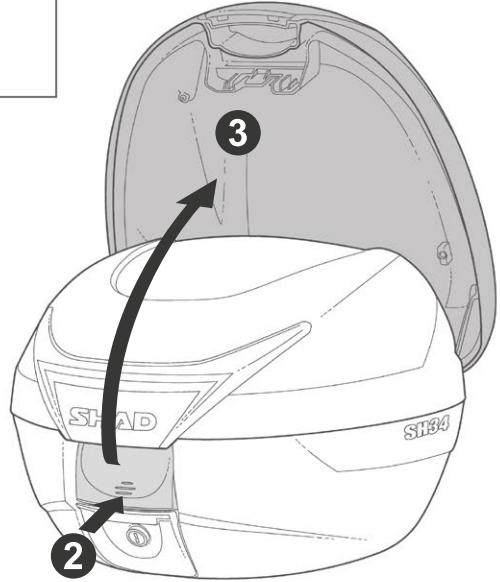
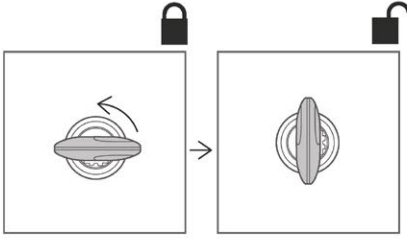

CLOSE

1

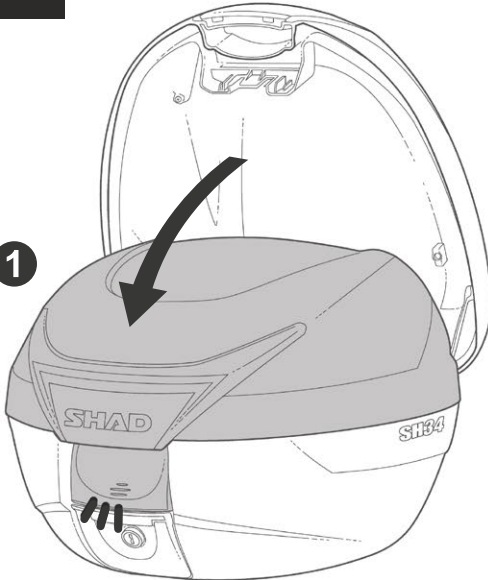

2

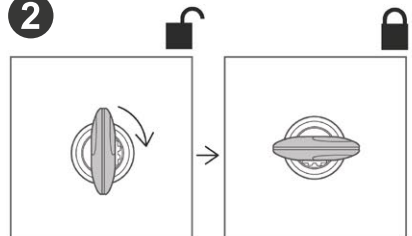

ASSEMBLY

1

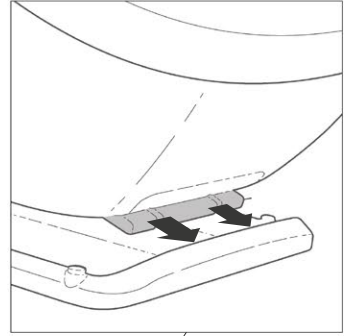
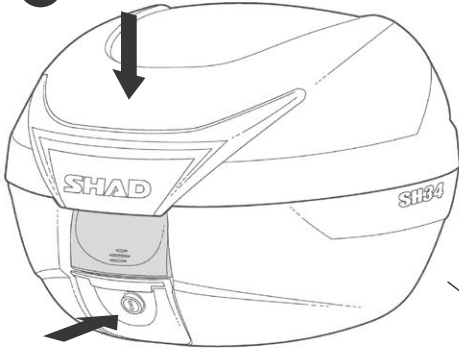

2

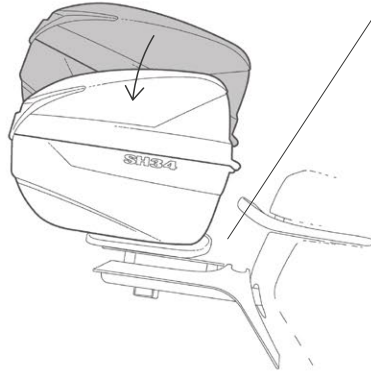

3

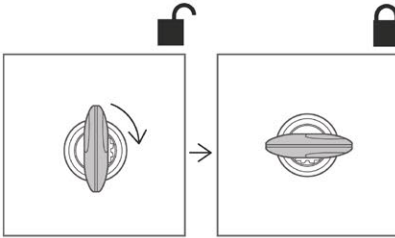

RELEASE

2

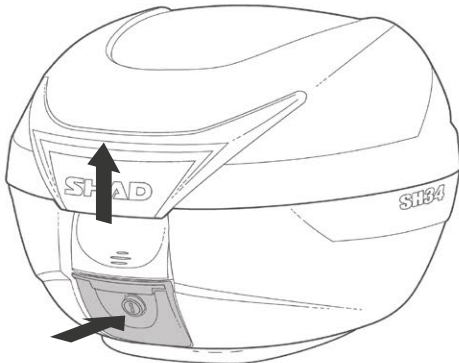

1

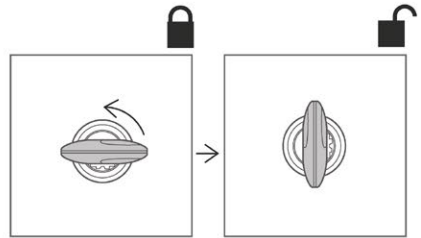

3

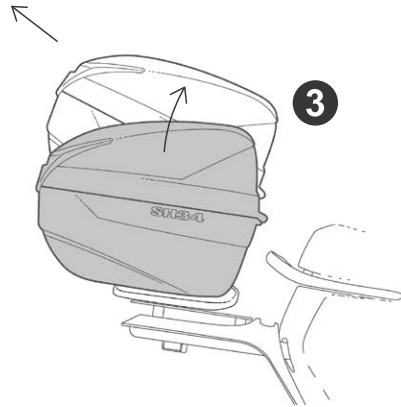

TOP CASE SUPPORT ASSEMBLY



1 201124 x1



2 201125 x1



3 200713/2 x4



4 304058 x4
M6x30 Din 965



5 304144 x4
M6x40 Din 965



6 303000 x4
Ø6



7 302021 x4
M6



8 201049 x4



PHILLIPS PH3



N° 10mm

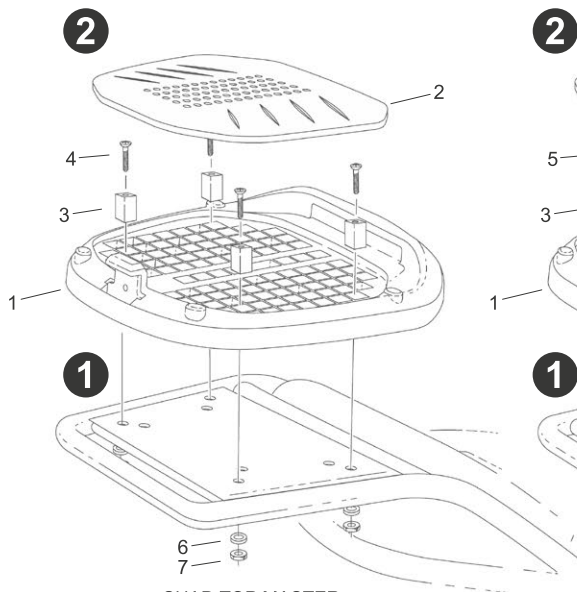

SHAD TOP MASTER

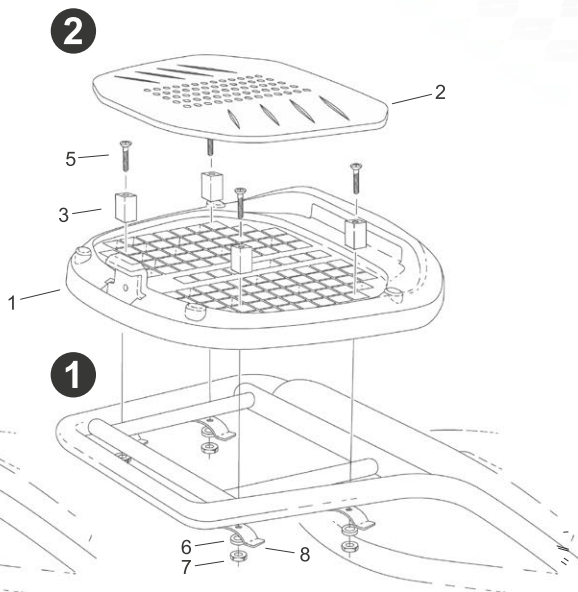

CHECK BIKE COMPATIBILITY
WWW.SHAD.ES *

ACCESSORIES

BACKREST
D0RI40



BRAKE LIGHT
D0B29KL



DESIGNED IN BARCELONA

Since 1973

SHAD EUROPE NAD S.L.
HEADQUARTERS

T: (+34) 935 795 866
Octave Lecante, 2-6
Mollet del Valles, 08100
Barcelona - Spain

SHAD CHINA

T: (+86) 21 6236 5730
Room 501 (Zone 1-T3),
No.1, Lane 268, Tai Hong Road,
MinHang District, 201107
Shanghai - China

SHAD USA

T: (+1) 305 652 6366
19096 NE 4th Court
Miami FL, 33179
USA

SHAD INDONESIA

T: (+62) 21 2271 8560
Jl. Kemang Selatan VIII No.56 Unit B
Jakarta 12730 Indonesia

WWW.SHAD.ES



WE ARE
DOING
GREEN

AS PART OF THE TERRA DEVELOPMENT PROJECT, FROM SHAD WE HAVE ACQUIRED THE COMMITMENT TO FIGHT AGAINST CLIMATE CHANGE BY REFORESTATION.



tree-nation

Tree-Nation is an open, collaborative platform to reforest the world.

Expand our SHAD forest
CAN YOU HELP US REFOREST?
JUST ENTER AND SEE HOW

WWW.SHAD.ES